

CLICK IT Pendant Track

Installation Manual



ACC.291 Ceiling Suspension Installation 1,5m

ACC.292 Ceiling Suspension Installation 3m

1

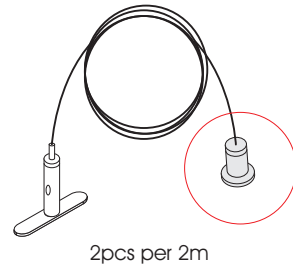

1.1

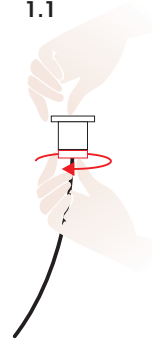

1.2

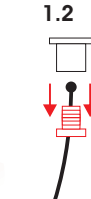

1.3

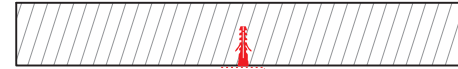

2

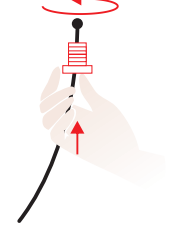

3

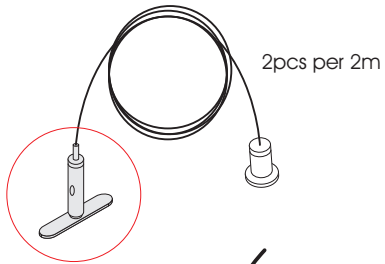

Attention!

The ceiling suspension must be strongly tightened to the track

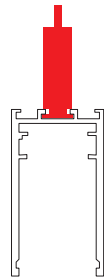

3.1

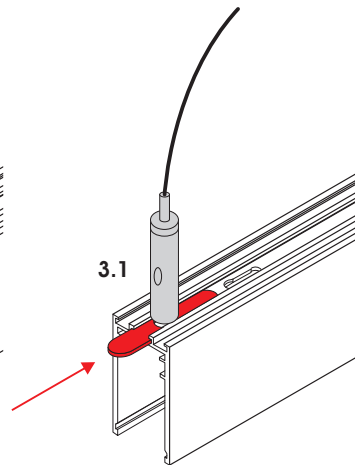

3.2

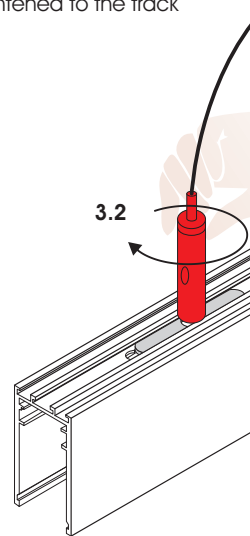

4

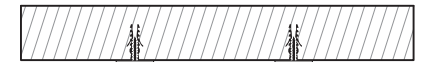

Press to adjust the height

